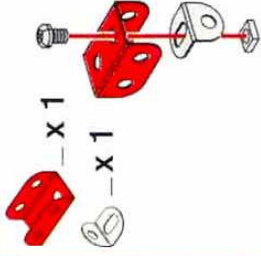
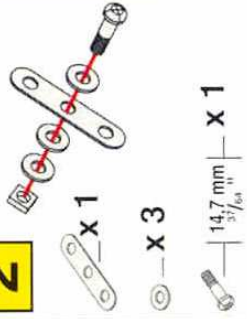
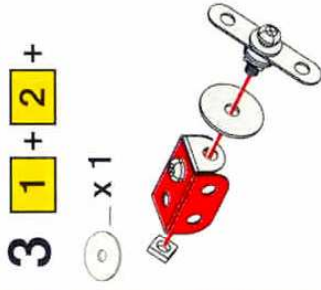
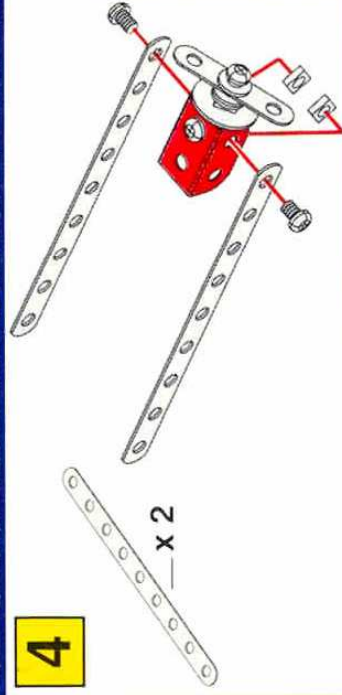
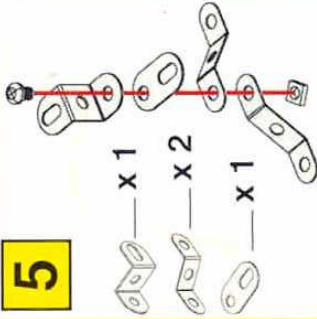
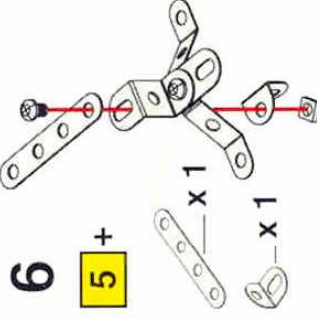
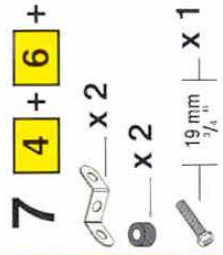
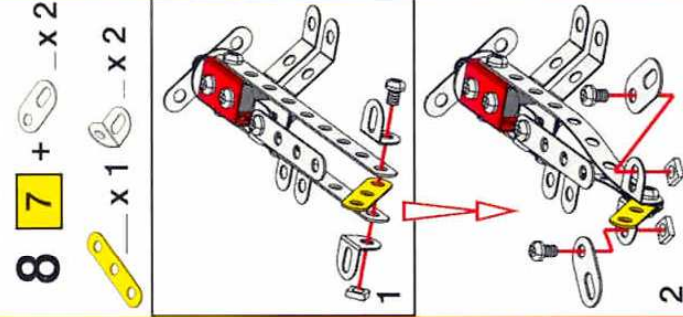

2104

SURVEY PLANE

2104

1**2****3****4****5****6****7****8**

2104

SURVEY PLANE

2104

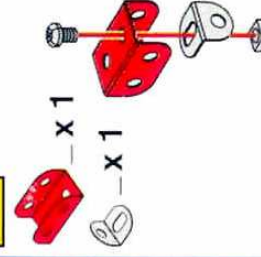
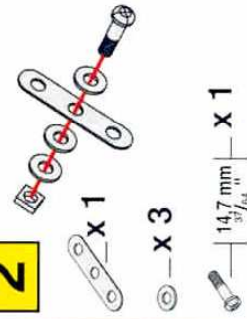
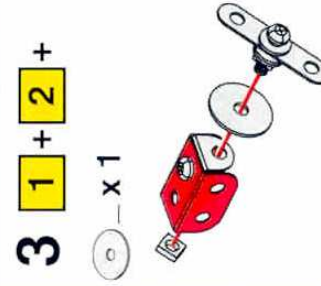
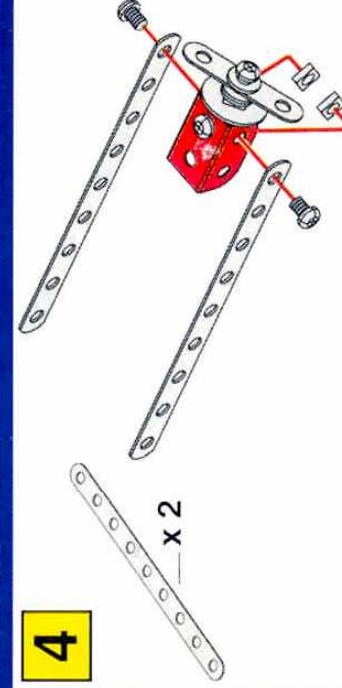
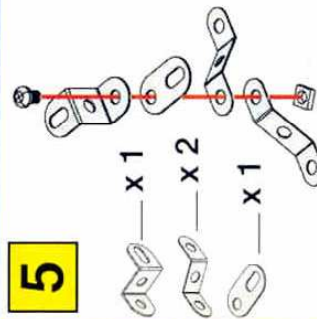
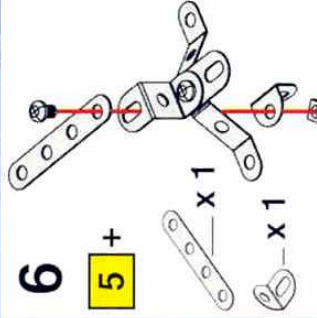
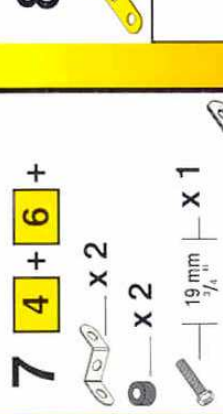
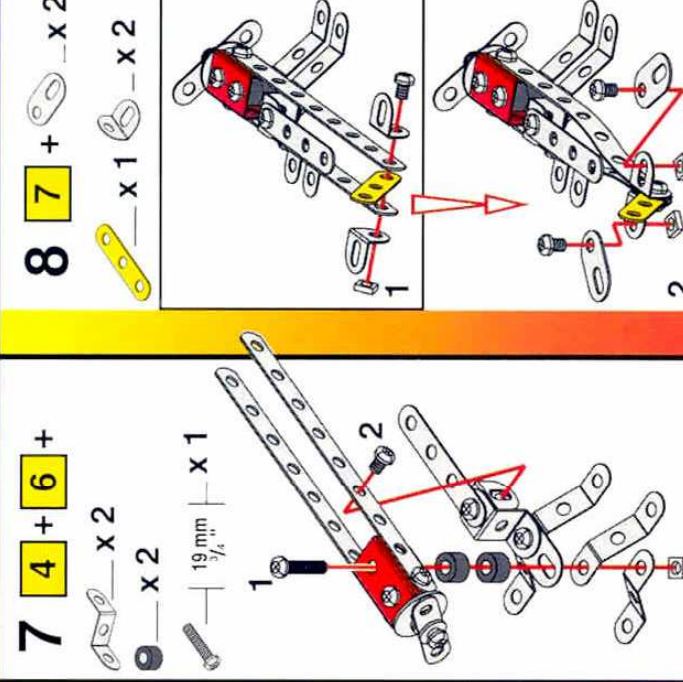
1**2****3****4****5****6****7****8**

9

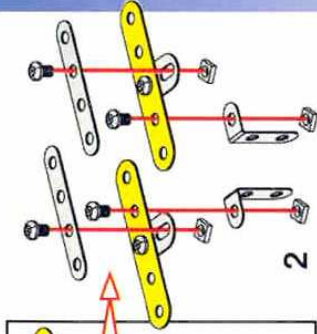
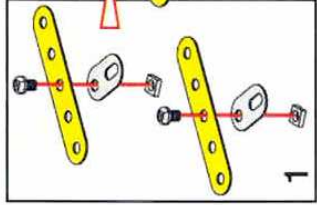
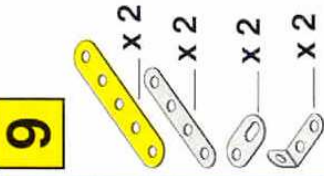

10 8 + 9

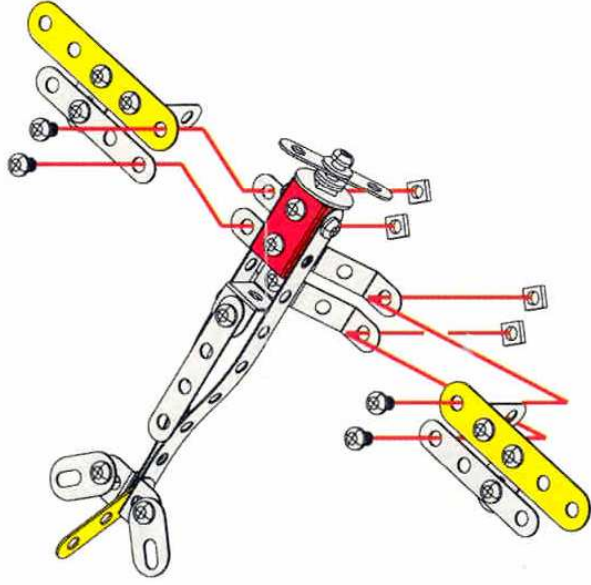

11

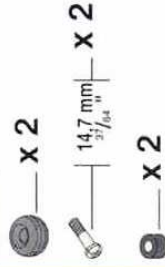

12

10 + 11

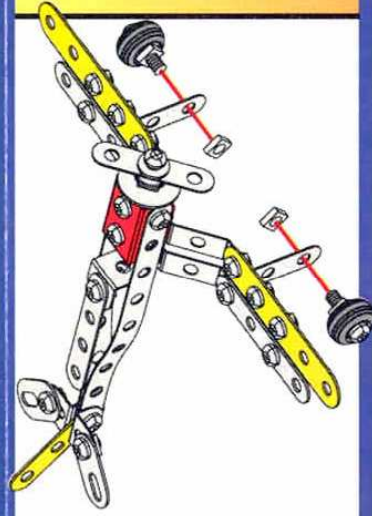

9

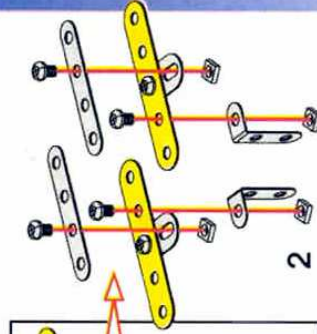
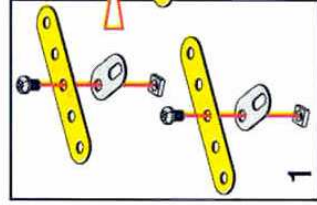
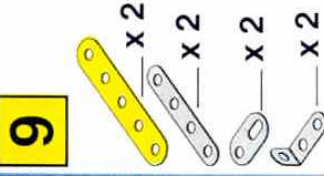

10 8 + 9

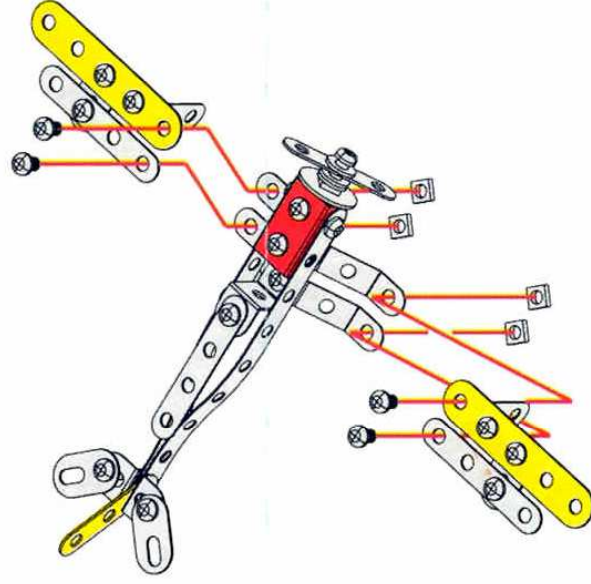

11

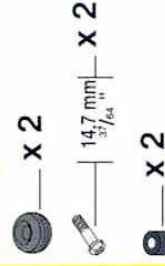

12

10 + 11

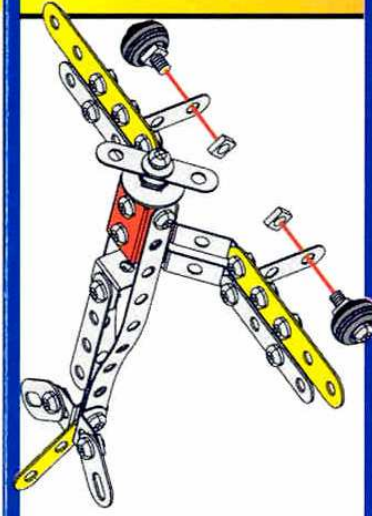

Many of the models and component parts are unique and original designs which are the property of MECCANO S.A. They are protected by patents in many countries. For detailed information, please contact MECCANO S.A.

Da nombro più MECCANO S.A. produca tutti i componenti originali e molti altri modelli unici, protetti da brevetti in molti paesi. Per tutte le informazioni, si prega di scrivere a MECCANO S.A.

Firma MECCANO S.A. Sie sind durch Ihre Rechte an den Erfindungen und Modellen sowie durch die Patente geschützt.

Numéro de modèle et pièces sont des créations originales, propriété de MECCANO S.A. et sont protégés par des brevets dans de nombreux pays. Pour toute information, s'il vous plaît contactez MECCANO S.A.

Модели и детали являются оригинальными, принадлежащими MECCANO S.A. и защищены патентами во многих странах. Для получения информации, пожалуйста, обращайтесь к MECCANO S.A.

Modelos e peças são criações originais, propriedade de MECCANO S.A. e são protegidas pelas legislações nacionais de diversos países. Para quaisquer informações, por favor, contactar a MECCANO S.A.

Модели и детали являются оригинальными, принадлежащими MECCANO S.A. и защищены патентами во многих странах. Для получения информации, пожалуйста, обращайтесь к MECCANO S.A.

Modelos e peças são criações originais, propriedade de MECCANO S.A. e são protegidas pelas legislações nacionais de diversos países. Para quaisquer informações, por favor, contactar a MECCANO S.A.

Modelos e peças são criações originais, propriedade de MECCANO S.A. e são protegidas pelas legislações nacionais de diversos países. Para quaisquer informações, por favor, contactar a MECCANO S.A.

Modelos e peças são criações originais, propriedade de MECCANO S.A. e são protegidas pelas legislações nacionais de diversos países. Para quaisquer informações, por favor, contactar a MECCANO S.A.

ERECTOR

Distributed by MECCANO® Inc.
1675 Broadway
New York, NY 10019

ERECTOR® instruction booklets are solely to assist in construction of sets. MECCANO, Inc. shall have no responsibility for I. Failure to follow instructions. II. Use of parts for any purpose other than as specified in the instruction booklets. III. Any alteration of any parts or components.

ERECTOR® and MECCANO® are exclusive trademarks of Meccano S.A.
© 1994 Meccano S.A. Made in France by MECCANO Avenue de Saint Exupéry, 62100 CALAIS.

MECCANO S.A. 95 bis, rue Bellevue
92100 Boulogne-Billancourt - FRANCE